

# SURGICAL BURS & HANDPIECES

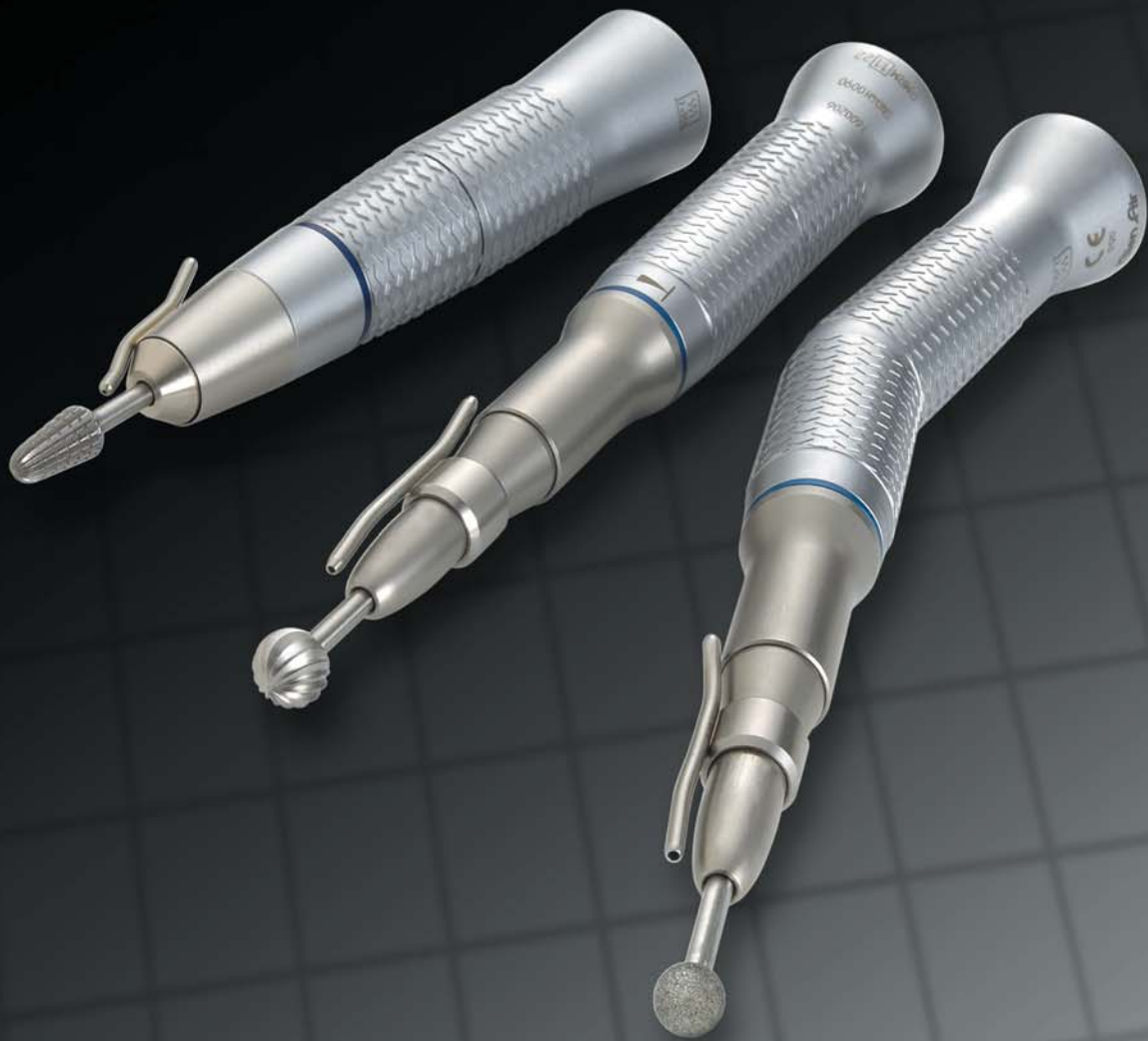

**MERCIAN**  
Surgical Instruments of Excellence

## Toller Round Head Bur

Tungsten Carbide  
with Blood Ring



Length	50mm	70mm
Head size	2.3mm	2.3mm
Code No.	<b>SB0144-23</b>	<b>SB0170-23</b>

1/1

Sterile Packed in boxes of 10

## Toller Taper Fissure Bur

Tungsten Carbide cross cut  
with Blood Ring



Length	50mm	70mm
Head size	1.6mm	1.6mm
Code No.	<b>SB0144-16</b>	<b>SB0170-16</b>

1/1

Sterile Packed in boxes of 10

## Apicectomy Bur

44mm length

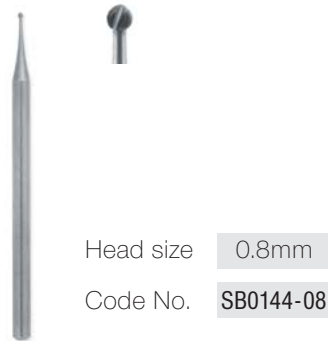

Head size	0.8mm
Code No.	<b>SB0144-08</b>

1/1

Sterile Packed in boxes of 10

## Micro Head Apicectomy Bur

10mm length  
Latch Fitting

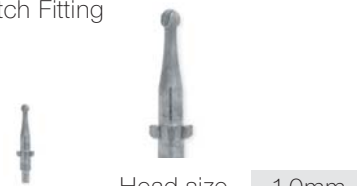

Head size	1.0mm
Code No.	<b>SB0110-10</b>

1/1

Sterile Packed in boxes of 5

## Round Head Bur

Plain cut  
44mm length



1/1

Head size	1.0mm	1.2mm	1.4mm	1.6mm	1.8mm	2.1mm
Code No.	<b>SB0244-10</b>	<b>SB0244-12</b>	<b>SB0244-14</b>	<b>SB0244-16</b>	<b>SB0244-18</b>	<b>SB0244-21</b>
	2.3mm	2.5mm	2.7mm	3.1mm	4.0mm	5.0mm
	<b>SB0244-23</b>	<b>SB0244-25</b>	<b>SB0244-27</b>	<b>SB0244-31</b>	<b>SB0244-40</b>	<b>SB0244-50</b>
	6.0mm					
	<b>SB0244-60</b>					

Sterile Packed in boxes of 10

## Flat Fissure Bur

Cross cut  
44mm length



1/1

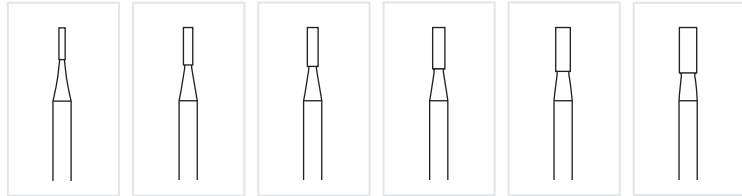

Head size	1mm	1.4mm	1.6mm	1.8mm	2.1mm	2.3mm
Code No.	SB0344-10	SB0344-14	SB0344-16	SB0344-18	SB0344-21	SB0344-23

Sterile Packed in boxes of 10

## Tapered Fissure Bur

Cross cut  
44mm length



1/1

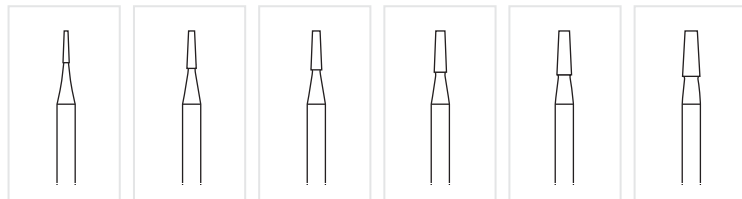

Head size	1mm	1.4mm	1.6mm	1.8mm	2.1mm	2.3mm
Code No.	SB0444-10	SB0444-14	SB0444-16	SB0444-18	SB0444-21	SB0444-23

Sterile Packed in boxes of 10

## Tapered Fissure Bur

Cross cut  
50mm length

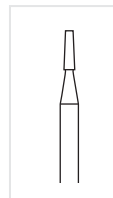

Head size	1.6mm
Code No.	SB0450-16

Sterile Packed in boxes of 10

1/1

# TRIMMER BURS

## Bud Bur

Cross cut

44mm length 1/1

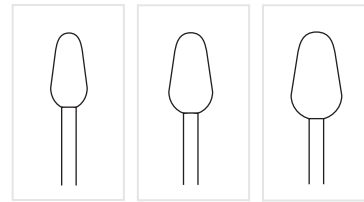

Head size

5mm	6mm	7mm
-----	-----	-----

44mm length Code No. **SB0544-50** **SB0544-60** -

70mm length Code No. **SB0570-50** **SB0570-60** **SB0570-70**

44mm Sterile Packed in boxes of 10  
70mm Sterile Packed in boxes of 5

## Cylinder Bur

Cross cut

44mm length 1/1

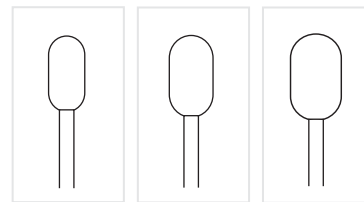

Head size

5mm	6mm	7mm
-----	-----	-----

44mm length Code No. **SB0644-50** **SB0644-60** -

70mm length Code No. **SB0670-50** **SB0670-60** **SB0670-70**

44mm Sterile Packed in boxes of 10  
70mm Sterile Packed in boxes of 5

## Pear Bur

Cross cut

44mm length 1/1

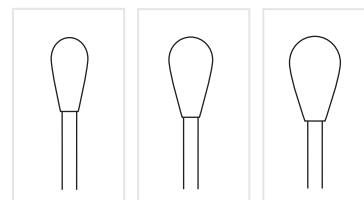

Head size

5mm	6mm	7mm
-----	-----	-----

44mm length Code No. **SB0744-50** **SB0744-60** -

70mm length Code No. **SB0770-50** **SB0770-60** **SB0770-70**

44mm Sterile Packed in boxes of 10  
70mm Sterile Packed in boxes of 5

# LINDEMANN SIDE CUTTING BURS

## Lindemann Side Cutting Burs

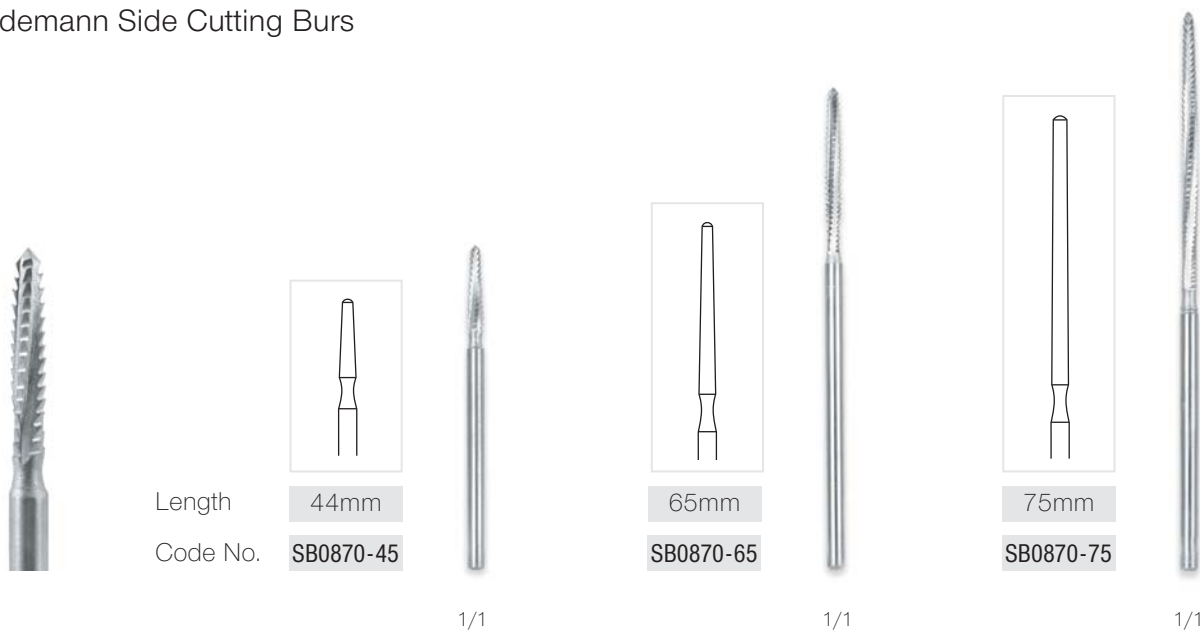

Sterile Packed in boxes of 5

# BONE TREPHINES

## Bone Trephines

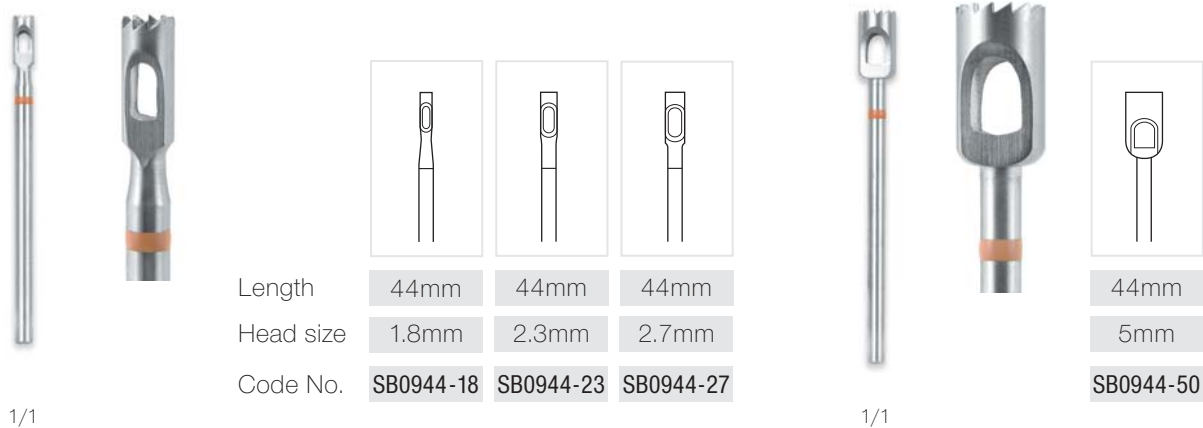

Sterile Packed in boxes of 5

Sterile Packed in boxes of 5

## ENT Cutting Bur

70mm length



1/1

Head size	0.6mm	0.7mm	0.8mm	1mm	1.4mm	1.8mm	2.3mm	
Code No.	<b>SB1170-06</b>	<b>SB1170-07</b>	<b>SB1170-08</b>	<b>SB1170-10</b>	<b>SB1170-14</b>	<b>SB1170-18</b>	<b>SB1170-23</b>	
	2.7mm	3.1mm	3.5mm	4mm	4.5mm	5mm	6mm	7mm
	<b>SB1170-27</b>	<b>SB1170-31</b>	<b>SB1170-35</b>	<b>SB1170-40</b>	<b>SB1170-45</b>	<b>SB1170-50</b>	<b>SB1170-60</b>	<b>SB1170-70</b>

Sterile Packed in boxes of 5

## ENT Allport Cutting Bur

70mm length  
6 Blades



1/1

Head size	0.6mm	0.7mm	0.8mm	1mm	1.4mm	1.8mm	2.3mm	
Code No.	<b>SB1270-06</b>	<b>SB1270-07</b>	<b>SB1270-08</b>	<b>SB1270-10</b>	<b>SB1270-14</b>	<b>SB1270-18</b>	<b>SB1270-23</b>	
	2.7mm	3.1mm	3.5mm	4mm	4.5mm	5mm	6mm	7mm
	<b>SB1270-27</b>	<b>SB1270-31</b>	<b>SB1270-35</b>	<b>SB1270-40</b>	<b>SB1270-45</b>	<b>SB1270-50</b>	<b>SB1270-60</b>	<b>SB1270-70</b>

Sterile Packed in boxes of 5

## ENT Polishing Bur

70mm length



1/1

Head size	0.6mm	0.7mm	0.8mm	1mm	1.4mm	1.8mm	2.3mm	
Code No.	SB1370-06	SB1370-07	SB1370-08	SB1370-10	SB1370-14	SB1370-18	SB1370-23	
	2.7mm	3.1mm	3.5mm	4mm	4.5mm	5mm	6mm	7mm
	SB1370-27	SB1370-31	SB1370-35	SB1370-40	SB1370-45	SB1370-50	SB1370-60	SB1370-70

Sterile Packed in boxes of 5

## ENT Diamond Bur

70mm length



1/1

Head size	0.6mm	0.7mm	0.8mm	1mm	1.4mm	1.8mm	2.3mm	
Code No.	SB1470-06	SB1470-07	SB1470-08	SB1470-10	SB1470-14	SB1470-18	SB1470-23	
	2.7mm	3.1mm	3.5mm	4mm	4.5mm	5mm	6mm	7mm
	SB1470-27	SB1470-31	SB1470-35	SB1470-40	SB1470-45	SB1470-50	SB1470-60	SB1470-70

Sterile Packed in boxes of 5

## Straight Oral Surgery Handpiece PM1124

1:1 Transmission  
For 44mm + 50mm Burs  
max speed 40,000RPM

Code No. **1600052-001**



Spray Nozzle Code No. **233-04-03**

## Contra-Angled Handpiece CA1122

1:1 Transmission  
For Latch Burs  
max speed 40,000RPM

Code No. **1600200-001**



## Straight Handpiece PM RM1122

1:1 Transmission  
For 70mm Length Burs  
max speed 40,000RPM

Code No. **1600206-001**



Spray Nozzle Code No. **233-06-26**

## Straight Handpiece PM RM1122

1:1 Transmission  
For 95mm Length Burs  
max speed 40,000RPM

Code No. **1600340-001**



Spray Nozzle Code No. **233-06-27**

## Angled ENT Handpiece PM AM1122

1:1 Transmission  
For 70mm Length Burs  
max speed 40,000RPM

Code No. **1600207-001**



Spray Nozzle Code No. **233-06-26**

## Angled ENT Handpiece PM AM1122

1:1 Transmission  
For 95mm Length Burs  
max speed 40,000RPM

Code No. **1600336-001**



Spray Nozzle Code No. **233-06-27**

## Angled ENT Handpiece PM AM1221

2x Speed Multiplier  
For 70mm Length Burs  
max speed 80,000RPM

Code No. **1600295-001**



Spray Nozzle Code No. **233-06-26**

## Angled ENT Handpiece PM AM1221

2x Speed Multiplier  
For 95mm Length Burs  
max speed 80,000RPM

Code No. **1600338-001**



Spray Nozzle Code No. **233-06-27**

## Reciprocating Micro Saw

Max. speed 15,000 rpm

68.24.10



Sterile Packed Blades in boxes of 12



11mm

68.24.12

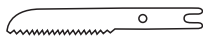

14mm

68.24.13

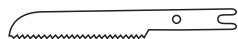
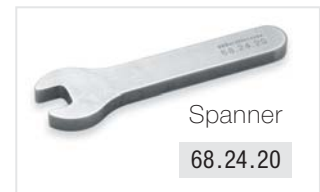

18mm

68.24.14

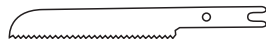

22mm

68.24.15



26mm

68.24.16

## Osseoscapel Micro Saw

Ideal for use on cranial bone

Max. speed 20,000 rpm

68.24.05



Sterile Packed Blades in boxes of 12

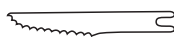

12mm

68.24.35



18mm

68.24.36

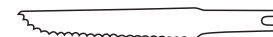

24mm

68.24.37

## Sagittal Micro Saw

Max. speed 20,000 rpm

68.24.02



Sterile Packed Blades in boxes of 12

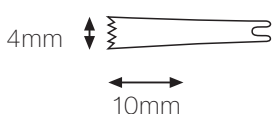

68.24.70

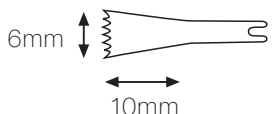

68.24.71

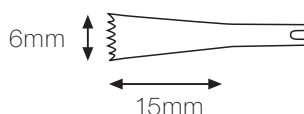

68.24.72

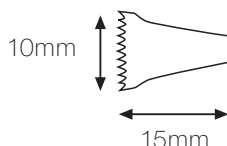

68.24.73

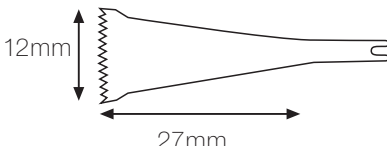

68.24.74

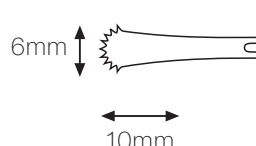

68.24.75

## Oscillating Micro Saw

Max. speed 15,000 rpm

68.24.00



Blades available with either 27mm short shaft or 42mm long shaft

Sterile Packed Blades in single units

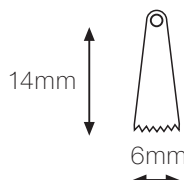

68.24.24



68.24.25

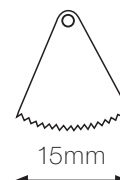

68.24.26

Saw Blades with Short Shaft 27mm length Code No.

Saw Blades with Long Shaft 42mm length Code No.

68.24.27

68.24.28

68.24.29

# SERVOTRONIC MICRO MOTOR

The Servotronic Micro Motor System is, equipped with the most up to date and most powerful micro motor which results in high levels of reliability.

The range of Handpieces now available allows a wide range of Surgery in Maxillo-Facial, E.N.T. and Craniofacial Surgery with both Bur Handpieces and Saw Handpieces available.

The precisely controlled Irrigation System results in the cutting tool continually irrigated to the Surgeons requirements.

- Autoclavable micro motor
- Irrigation System
- Wide range of Saw Handpieces
- Digital Display
- Memorises previous settings

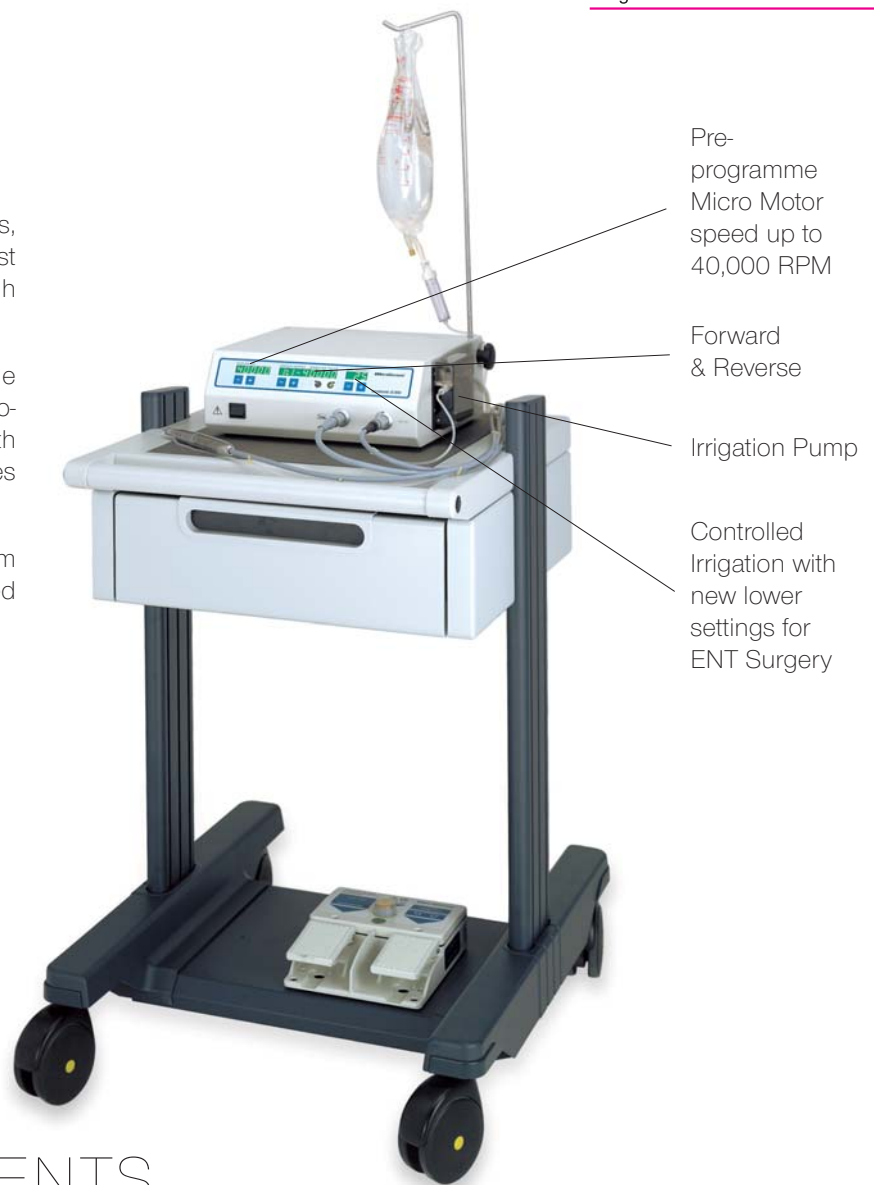

Pre-programme Micro Motor speed up to 40,000 RPM

Forward & Reverse

Irrigation Pump

Controlled Irrigation with new lower settings for ENT Surgery

## MAIN COMPONENTS



### ELECTRONIC CONSOLE

The electronic console allows the user to select the maximum speed required also the irrigation flow. There is also the possibility of selecting forward & reverse.



### FOOT PEDAL

A foot pedal allows the constant control over the speed range of the micro motor. From the foot pedal you can also switch the irrigation on/off and switch the micro motor into forward or reverse.



### IRRIGATION SYSTEM

The irrigation system is easy to set up and precisely controllable. The rotary pump runs in sync with the micro motor.

Lower settings for E.N.T. Surgery allows a fine flow of irrigation onto the Bur.



### MICRO MOTOR

The Basch sterilizable micro motor is a high performance self cooling micro motor. Brushless with a variable speed range from 500 to 40,000 rpm.



# **MERCIAN**

**Surgical Instruments of Excellence**

established over  
40 years

Mercian Surgical Supply Co. Limited

10 Wolverhampton Road, Warley, Birmingham B68 0LH. UK.

Tel: +44 (0) 121 429 1133/1155 Fax: +44 (0) 121 429 4983 Email: [info@merciansurgical.com](mailto:info@merciansurgical.com)